



GRAND 6-PART SYSTEM INSTALLATION INSTRUCTIONS

TOOLS REQUIRED: The System includes 1/4" hexhead screws. To install the System, you will need:

- ratcheting driver
- cordless drill
- screw starter
- chalk or other marker
- manual screwdriver
- hacksaw

The following is a list of components:

Purpose:

1	48-inch or 36-inch primary Dehumidifier	Removes excess moisture from the piano
1	24-inch secondary Dehumidifier	
1	Humidistat	Controls the Humidifier and Dehumidifiers
1	Humidifier	Supplies moisture to the piano
1	Water Sensor Probes	Measure water depth in Humidifier
1	Humidifier Heater Bar	Warms pads to aid evaporation
1	Two-Light Panel	Shows System is energized and when to add water
1	Watering tube	Enables the delivery of water to the Humidifier
2	Humidifier pads	Used to vaporize moisture from the Humidifier
2	21-inch hanger rods	Used to suspend the Humidifier
1	Moisture Distribution Baffle	Dispenses moisture throughout the piano
1	Watering can	For adding water to the Humidifier
1	Bottle of Humidifier Treatment	Inhibits mildew in both the watering tube and Humidifier
1	Triple Outlet	Connects Dehumidifiers to Humidistat
1	Hardware kit	Described below
1	Tech neck rest	Prevents neck strain during the installation
1	System Care and Maintenance Sheet/5-year Warranty Certificate	

The hardware kit includes the following:

2	2-inch #6 screws	Used to mount the Humidistat
26	1/2-inch #8 screws	Mounts Dehumidifier clips, Humidifier hanger brackets, cord clamps
2	3/16-inch clamps	Attaches water sensor wire between tank and Humidistat
3	3/16-inch clamps	Attaches wire between light panel and Humidistat
2	1/2-inch standard clamps	Attaches watering tube between rim and Humidifier
2	1/8-inch clamps	Attaches optional SB wires to beam, if necessary
2	1 x 3 inch Velcro strips	Used to mount Humidistat
1	Alcohol pad	Used to clean beam before mounting Humidistat with Velcro
2	Wire ties and cable ties	Used to bundle excess cords
2	1/2-inch standard clamps	Used to bundle excess cords
2	3/4-inch #8 screws	Used to mount light panel
2	Half clamps and serrated washers	Attaches the end of the watering tube to the rim
6	1/4-inch clamps	Anchors Humidistat power cord wire
4	4-inch plastic hanger rod brackets	Holds hanger rods in place to suspend Humidifier
4	Dehumidifier rod clips	Used to mount Dehumidifiers
1	Warranty Registration card	

Smart Bracket package includes:

1	Smart Bracket Sensors	Attaches to Humidifier heater bar and senses when pads are dry
1	Single-Light Cube	Signals when Humidifier pads are dry

While we make every effort to ensure all components are included, it is a good idea to check that none are missing prior to arriving at the installation location. In the unlikely event that a part is missing, please call toll-free 800-438-1524 with information from the end of the box and the assembler's name. We will provide same-day shipment of the replacement part.

To the Piano Technician Installer

CAUTION

You are responsible for making a proper System installation by carefully following these instructions.

PLEASE PAY STRICT ATTENTION TO THE FOLLOWING ISSUES:

- 1) The soundboard of a grand piano can be exposed to condensation if the Humidifier is installed too close to the soundboard, counter to the instructions. Specifically, do not shorten the Humidifier hangers if you are making a between-the-beams installation.
- 2) If a cord/wire in the System is installed in direct contact with a Dehumidifier heating rod, over time, the cord/wire could dry out and crack, posing a fire or shock hazard. Carefully anchor cords/wires away from the Dehumidifiers with the ties and clamps provided with the System.
- 3) Do not use a Dehumidifier in the action of the piano without a Humidistat to control it. To dehumidify the action, we recommend you install a 36-inch, 25 watt Dehumidifier outside the case, under the keybed, and plug this Dehumidifier into the System's Humidistat.
- 4) Advise your clients that they should only use the Damp-Chaser brand of Humidifier Treatment in the Humidifier. Other brands of humidifier treatment may contain acids which can corrode strings and metal parts in the piano. Use of another brand of treatment voids the System's warranty and may also void the piano manufacturer's warranty.

OTHER IMPORTANT INFORMATION

- 1) The newly-installed Piano Life Saver System will alter the piano's wood-moisture content and, therefore, alter the tuning. Ideally, the System should be installed 3 weeks BEFORE the piano is tuned.
- 2) A frayed or cracked electrical cord/wire can cause a fire or shock. If the piano runs over the power cord it can be damaged. Please inspect the System's cords/wires each time you service the piano. See page 8 for information about the Fused Plug on the Humidistat power cord.
- 3) Installation of the Piano Life Saver System must be made by a professional Piano Technician or Tuner. Any warranties stated or otherwise implied are void if the installation is made by someone other than a professional Piano Technician or Tuner.

Warranty Service Call Policy: The 5-Year Warranty for this System covers parts only. Damp-Chaser Corp. assumes no responsibility for piano technician labor in maintenance, repair or warranty service calls related to the Piano Life Saver System. When Systems are priced according to the manufacturer's guidelines, most installers agree there is sufficient compensation to cover a possible warranty service call. At the time you install the System, please explain any post-installation fees to the System owner.



DAMPP-CHASER CORPORATION

Toll-free: 800-438-1524 • 828-692-8271 • Fax: 828-692-8272
www.PianoLifeSaver.com • e-mail: piano@damp-chaser.com
Post Office Box 1610 • Hendersonville, North Carolina 28793

STEP 1. PLANNING THE INSTALLATION

It is critical to plan the installation of the Piano Life Saver. You will be working under the piano to make the installation. The first component that should be considered is the Humidifier. The Humidifier can be installed between-the-beams (**Figure 1**) or under-the-beams (**Figure 2**). The between-the-beams installation is preferable because it provides better moisture distribution; and, if appearance is important, it is less visible than the under-the-beams installation. In either a between-the-beams or an under-the-beams installation, the Humidifier must be located so that the moisture distribution baffle (black plastic roof-shaped part that fits above the Humidifier) is level and not bent, bunched up or pointing up or down. **Figure 3** shows the correct alignment of the baffle over the tank. The Humidifier should be located as close to the center of the soundboard as beam construction will allow. Make sure that there will be adequate air flow around the tank. Please note the Water Sensor Probes and Humidifier Heater Bar are attached to the Humidifier at the factory. The Water Sensor Probes are attached to the Humidifier Heater Bar mounting bracket at the middle of the Humidifier (**Figure 3**).

If the piano does not have beams, use a support rods package (model number 48A) to allow installation of the Humidifier. This package must be ordered separately and comes with its own instructions.

Once the location for the Humidifier has been selected, a location for the Humidistat should be chosen. The Humidistat should be mounted as close as possible to the soundboard. It should be located at least at the top of the beam. It should be mounted so that the openings are up (**Figure 4**) and should be placed about 6" from the Humidifier. It should be noted that the two end vent holes on the Humidistat act as a "chimney" to vent heat from the Humidistat. Do not obstruct the holes when the Humidistat is mounted in the piano (**Figure 4-A**). Plan your Humidistat installation so the soundboard ribs do not lie over the two vents.

The Dehumidifiers should be located at least 12" from the Humidistat. The 48-inch or 36-inch primary Dehumidifier should be located under the soundboard, across the bottom surface of the beams and as close as possible to the front of the piano, i.e. just behind the belly rail. This location provides some dehumidification to the action as well as the soundboard.

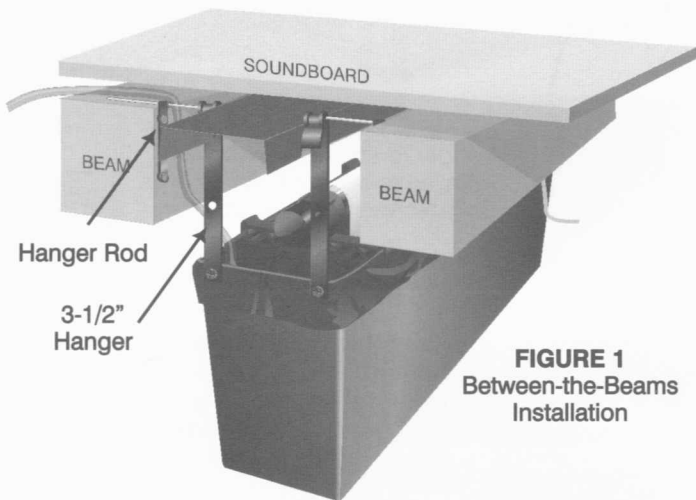

FIGURE 1
Between-the-Beams
Installation

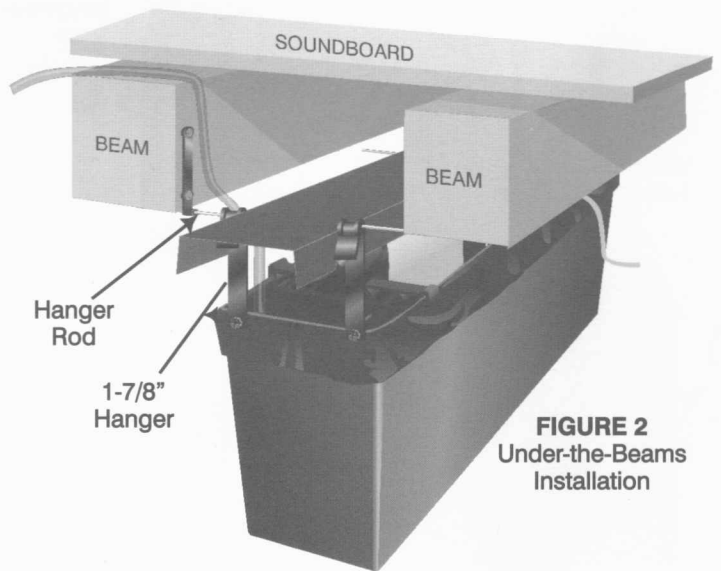

FIGURE 2
Under-the-Beams
Installation

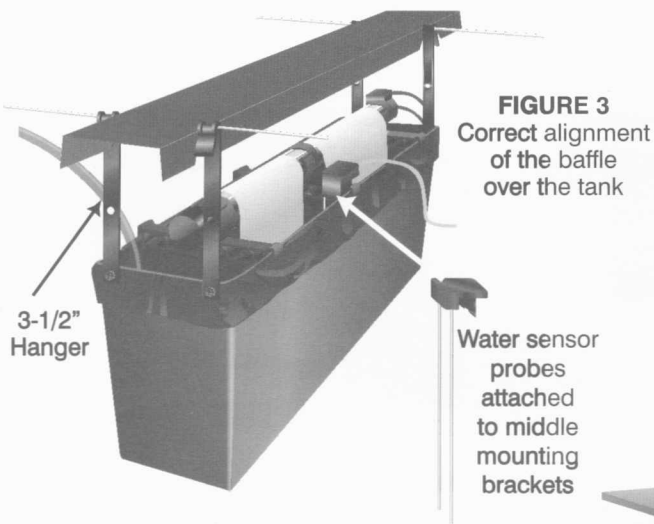

FIGURE 3
Correct alignment
of the baffle
over the tank

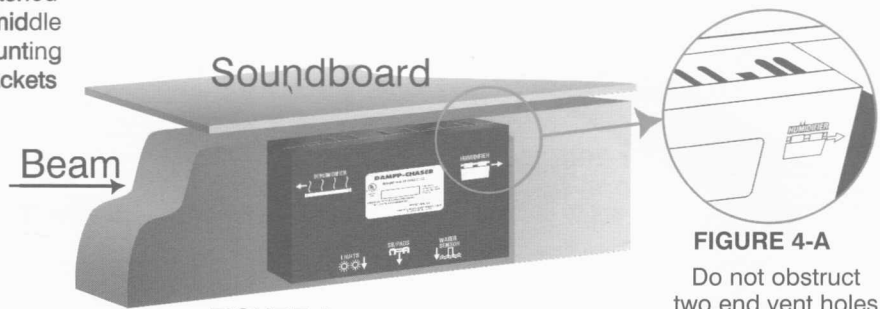

FIGURE 4

FIGURE 4-A
Do not obstruct
two end vent holes
during installation

The 24-inch secondary Dehumidifier should be located under the soundboard, across the beams and within several inches of the tail of the piano. **Figure 5** shows typical locations of the Humidifier, Humidistat, and primary and secondary Dehumidifiers.

To protect the action from high humidity, mount a 36-inch, 25-watt Dehumidifier under the keybed and control it with the Humidistat. It can be plugged into the triple outlet on the Humidistat for the Dehumidifiers. **Do not place a Dehumidifier in the action.**

STEP 2. HUMIDIFIER INSTALLATION

Following the installation plan, the Humidifier is the initial component to go into the piano. First the hanger rods must be attached to the piano so that the Humidifier tank can be suspended from the hanger rods. This is true for both a between-the-beams and an under-the-beams installation. **The between-the-beams installation will be discussed first since it is the recommended installation (Figure 6).** In a between-the-beams installation, the hanger rods are positioned just above the beams (**Figure 6**). The flat side of the hanger rod bracket are against the beam.

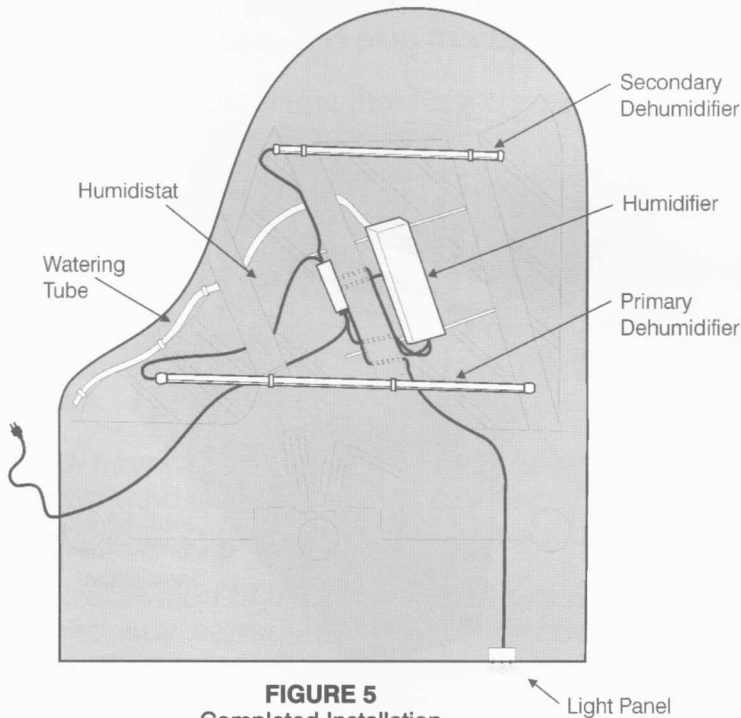

FIGURE 5
Completed Installation
(View of Piano as you lie under it with your head pointed towards the tail of the piano)

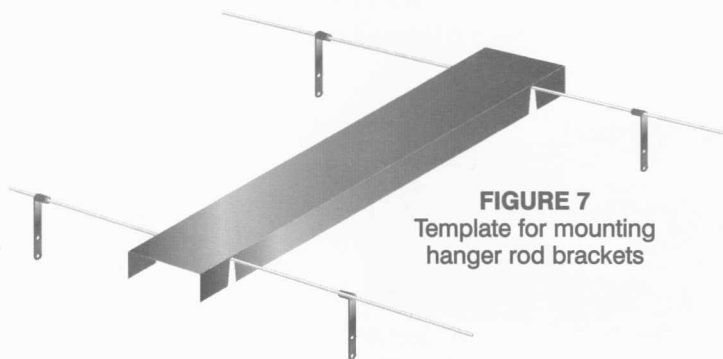

FIGURE 7
Template for mounting hanger rod brackets

The moisture distribution baffle and the hanger rods can be used as a template for locating the hanger rod brackets (**Figure 7**). First, attach the hanger rod brackets to the hanger rods with the molded extensions pointing in. Place the hanger rods above the beam and attach the baffle to the hanger rods in the location you planned to install the Humidifier. Slide all four hanger rod brackets into contact with the beam. Screw 1/2-inch screws into the beams through the bottom hole on the hanger brackets. Do not over tighten.

In rare cases there may be insufficient clearance between the ribs of the soundboard and the moisture distribution baffle when the hanger rods are positioned above the beams. In this situation, you will use your hacksaw to cut the hanger rods to lengths that fit on the side of the beams at appropriate points to hold the moisture distribution baffle away from the ribs (**Figure 8**).

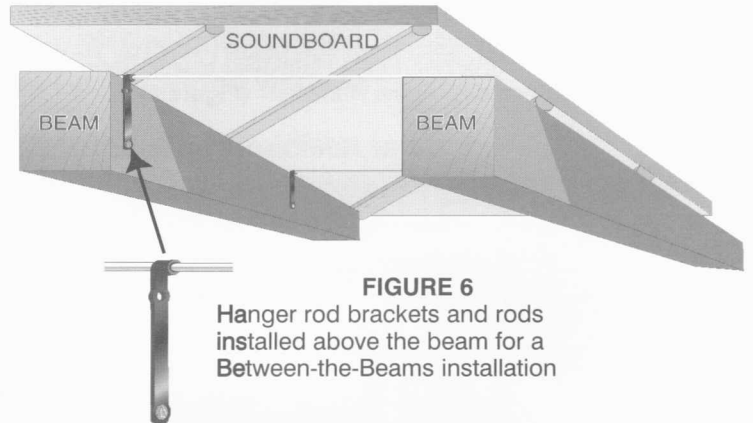

FIGURE 6
Hanger rod brackets and rods installed above the beam for a Between-the-Beams installation

Note: The H-5 Humidistat should be located 6" from the Humidifier in a Grand Installation.

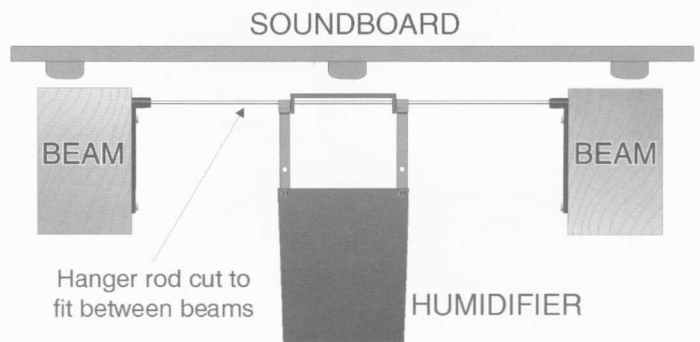

FIGURE 8
Mount the tank hanger rods on the side of the beams when there is insufficient clearance between the ribs and the baffle

In the under-the-beams installation the hanger rod brackets are attached at the bottom of the beams (**Figures 2 and 9**). In the under-the-beams installation the baffle/hanger rod assembly (**Figure 7, page 4**) is also used as a template for locating the hanger rod brackets.

The next step is to attach the Humidifier to the hanger rods. Note that the hangers for the Humidifier have two holes in them (**Figure 10**). For a between-the beams installation use the lower hole; the Humidifier comes this way as it is the recommended installation. For an under-the beams installation, move the hangers and use the upper hole, i.e., the one closest to the hook. **Attention: In no case should you use the upper hole for a between-the-beams installation as this position may expose the soundboard to damage from condensation.**

To move the hangers, simply unscrew the 1/2-inch screws on the tank, move the hangers down so that the holes align and then refasten with the screws. These screws do not require wing nuts to secure them because they are self-locking and will not loosen. If necessary, enlarge the holes in the plastic Humidifier liner with a pair of scissors. To prepare the Humidifier for hanging, uncoil the fill tube and bring the loose end out of the tank. Remove the two-light panel and the Humidifier pads and put aside for later use.

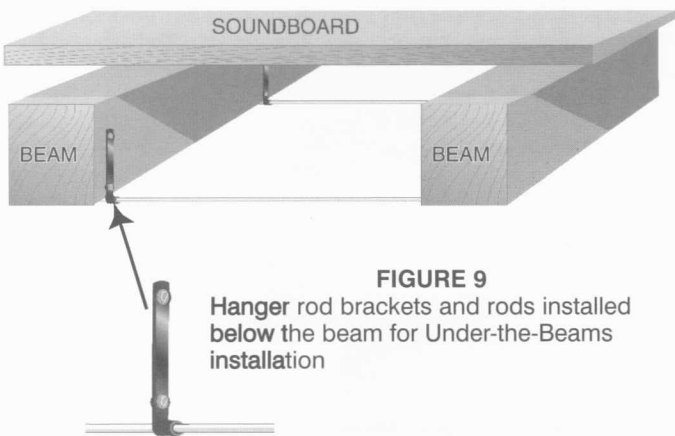

FIGURE 9

Hanger rod brackets and rods installed below the beam for Under-the-Beams installation

Humidifier Smart Bracket

If the System includes the optional Smart Bracket (SB), the bracket sensors will signal via a red light when the pads no longer wick water and require replacement. The SB also turns itself off when the pads fail or when the Humidifier runs out of water.

Mounting the Smart Bracket: Open the SB package and take out the SB sensors with attached C clips. Put aside the SB single-light cube for later use. To attach the sensors to the heater bar, slide the C clips on the sensors into the position shown in **Figure 11** and press firmly downward. The sensors on the SB should lie on the top of the heater bar.

The Humidifier pads are designed to wick water over the heater bar, producing warm, moist currents which rise and are circulated throughout the piano. Drape the Humidifier pads across the heater bar and push them down into the tank as shown in **Figure 3 on page 3**. If necessary, adjust the C clips on the SB sensors to insure the pads are in direct contact with the sensors. Unbundle the cords from the SB, the Water Sensor probes and the Humidifier heater bar.

Lift the Humidifier into position so the hangers go over the hanger rods on the outside of the baffle (**Figure 12**).

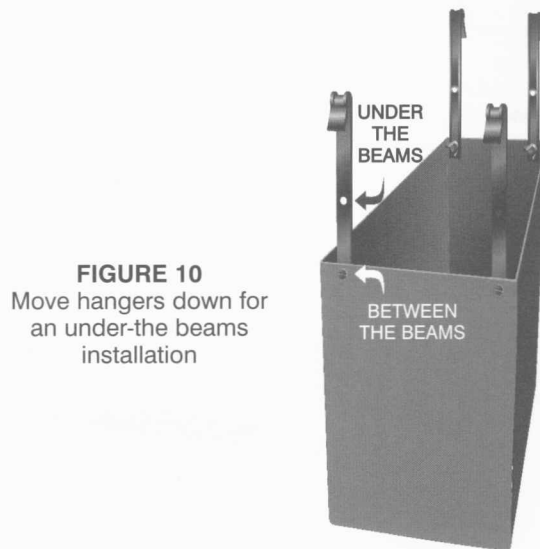

FIGURE 10

Move hangers down for an under-the beams installation

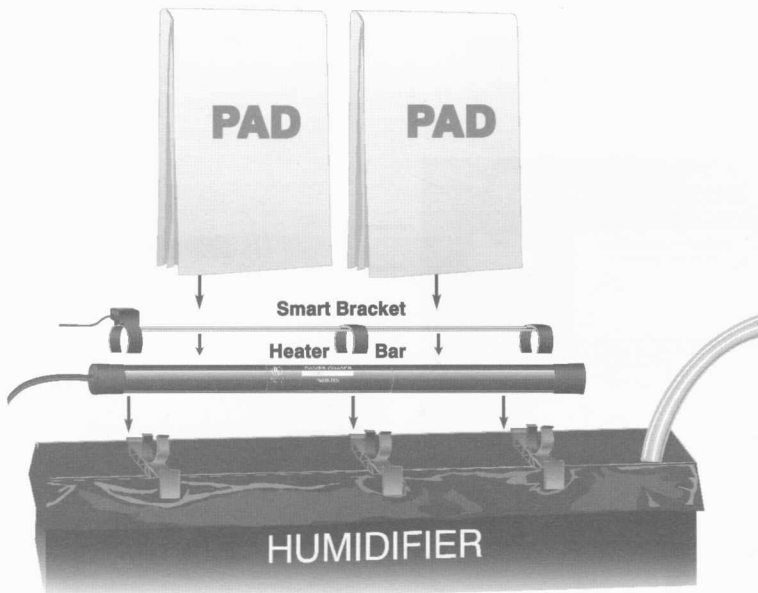

FIGURE 11

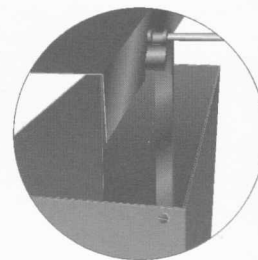

FIGURE 12

Hangers go on the outside of the baffle

STEP 3. HUMIDISTAT INSTALLATION

The next step is to install the Humidistat. As mentioned in the installation planning phase, the two vent holes on the right side of the top of the Humidistat must not be obstructed by the soundboard ribs (**Figure 13**).

The Humidistat should be mounted as close as possible to the soundboard. It should be located at least at the top of the beam (**Figure 4 page 3**). The Humidistat should be placed about 6" from the Humidifier. Clean the area on the beam where the Humidistat will be located with the alcohol pad. Let the area dry thoroughly. Attach the Velcro strips to the Humidistat (**Figure 14**). Remove the backing from the strips and push the Humidistat firmly against the beam. Insert the 2-inch screws

through the Humidistat case and into the beam. **Use the screws to mount the Humidistat. Do not use the Velcro for permanent mounting.**

The 1/4" clamps may be used to attach the Humidistat power cord to the inside of the piano.

Run the Humidifier heater bar cord (with the white plug) over the beams and plug it into the white Humidistat outlet marked **HUMIDIFIER** (**Figure 15**). Next, run the white cord with the telephone jack adaptor over the beams and plug into the Humidistat outlet marked **WATER SENSOR**. If using the optional Smart Bracket, run the black cord with the phono jack adaptor over the beams and plug it into the Humidifier outlet marked **SB/PADS**.

KEEP RIBS CLEAR OF TWO END VENT HOLES

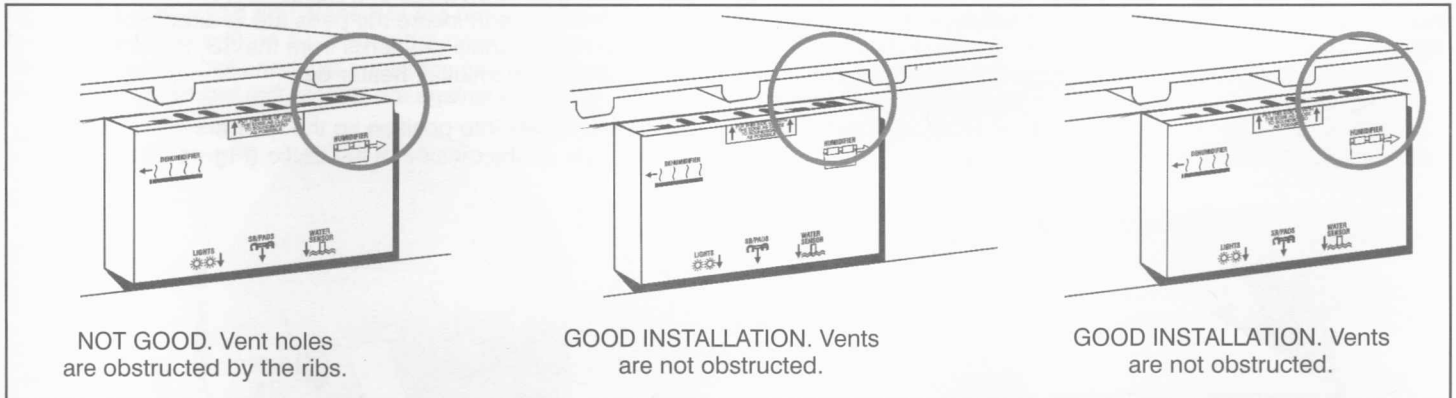

FIGURE 13

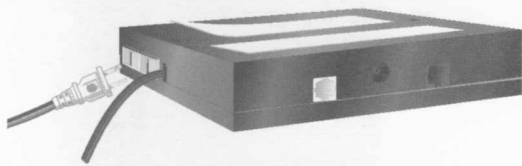

FIGURE 14
Attaching Velcro to the Humidistat.
White Humidifier Heater Bar
plug color is coded to white
Humidistat outlet

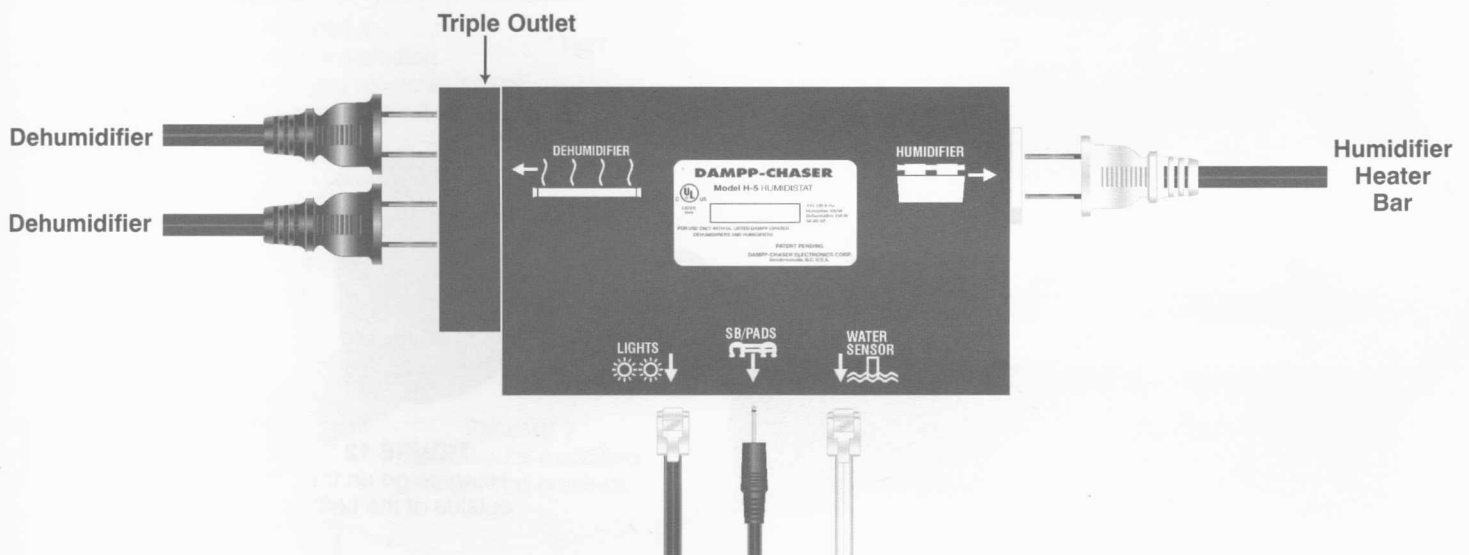

FIGURE 15

STEP 4. DEHUMIDIFIER INSTALLATION

The next step is to install the two Dehumidifiers. Snap the mounting clips onto the 48-inch or 36-inch primary Dehumidifier and place the assembly in the planned installation position. Mark around the clips with chalk. Remove the clips from the rod and attach them in the marked areas with the 1/2-inch screws. Snap in the Dehumidifier so that it is centered in the piano with the cord end closest to the Humidistat. Plug the triple outlet into the Humidistat outlet marked **DEHUMIDIFIER** and plug the Dehumidifier plug into the triple outlet (**Figure 16**).

The 24-inch secondary Dehumidifier is installed at the tail of the piano the same way the primary Dehumidifier was. The spacing on the mounting clips may be quite narrow in installations where there is only one beam in the tail of the piano. The secondary Dehumidifier plugs into the triple outlet also.

STEP 5. WATERING TUBE INSTALLATION

The next step is to complete the installation of the watering tube. **Figure 5 on page 4** shows a typical installation. The tube should be routed over the beams. **Figure 17** shows the two types of watering tube clamps included with the System. At the rim of the piano mount two half clamps to hold the end of the tube so it can be removed when the Humidifier needs to be filled. Use 1/2-inch #8 screws with serrated washers to anchor the half clamps and washers (the serrated washers bite into the wood to stabilize the clamp). Two 1/2-inch standard clamps are used to hold the watering tube between the rim and the Humidifier. The amount of tubing available to be removed should be sufficient to reach the top of the rim of the grand piano, since the fill point must be higher than the top of the Humidifier tank.

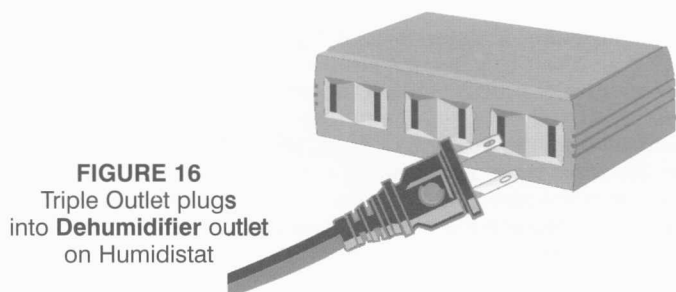

FIGURE 16
Triple Outlet plugs into **Dehumidifier** outlet on Humidistat

STEP 6. LIGHT PANEL INSTALLATION

The two-light panel (**Figure 18**) features a green light marked **POWER** to indicate the System has electrical power and a yellow light marked **WATER** which blinks when the Humidifier needs to have water added.

If the System includes the optional Smart Bracket (SB), there will be a single-light cube with a red light. The red light, marked **PADS**, will blink when the pads need to be replaced. Connect the two-light panel and single-light cube together (**Figure 18**) by inserting the tongue-latch and two prongs (on the side of the single-light cube) into the corresponding openings on the two-light panel. Insert the metal prongs first while firmly pushing the panels together. **NOTE:** the tongue-latch is slightly bent to create a snug fit between the two panels.

Locate the light panel under the rim or under the keybed, whichever is most visible (**Figure 19**). Unbundle the wire attached to the light panel. Attach the light panel with two 3/4-inch screws. Run the black light-panel wire over the top of beams and plug the light panel telephone jack into the **LIGHTS** outlet on the Humidistat. Use (3) 3/16-inch clamps with 1/2-inch screws to hold the wires from the light panel to the Humidistat.

Be sure none of the cords/wires touch the Dehumidifier rods, as exposure to heat can damage the cords/wires.

Anchor all excess wire for a neat installation. Conceal the wires and cords using a combination of ties taken from bundled wire, cable ties and the remaining clamps. Then, plug the Humidistat into a **non-switchable** wall outlet.

Continued on page 8



FIGURE 17
Two types of clamps for Watering Tube:
(A) standard clamp
(B) half clamp

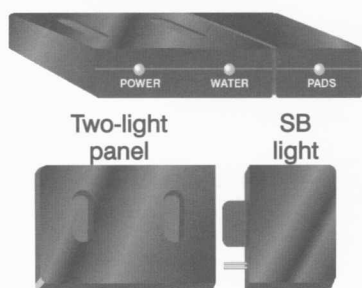

FIGURE 18
Push tongue-latch and prongs into openings

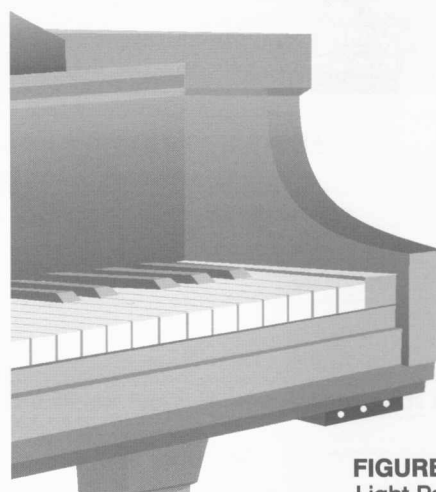

FIGURE 19
Light Panel installation

Notice the new Fused Plug on the Humidistat Power Cord in Figure 20. In the event of damage to the cord, or a direct lightning strike, the fuse in the plug will “blow out” and prevent the flow of electricity through the power cord, thus preventing any further damage. The plug contains two 5-AMP, 125-Volt glass fuses. If the green POWER light is not on, advise the piano owner to unplug the System and inspect the cord for damage. If there is no damage, remove the fuse from the brass clips inside the plug and replace it with the spare fuse in the plug. If the cord is damaged, the Humidistat should not be plugged into an electrical outlet. Call our technical support number for instructions, (800) 438-1524 or (828) 692-8271.

Only 5-AMP, 125-Volt, 5 mm x 20 mm, fast-acting, glass fuses should be used in the plug. Never use a fuse with greater amperage than 5 AMPS. These fuses are readily available at electronics stores such as Radio Shack. In the event you cannot find the fuses, Damp-Chaser has a supply.

STEP 7. WATERING THE SYSTEM

The final step is to fill the Humidifier with water. **FILL THE HUMIDIFIER WITH ONE WATERING CAN FILLED TO THE FULL CAN MARK.** Instruct the piano owner to add a watering can filled to the full can mark whenever the yellow low water warning light blinks. Also, instruct the piano owner to add one capful of Humidifier Treatment to each full watering can. Humidifier Treatment inhibits mildew in both the watering tube and the Humidifier tank and increases the life of Humidifier pads.

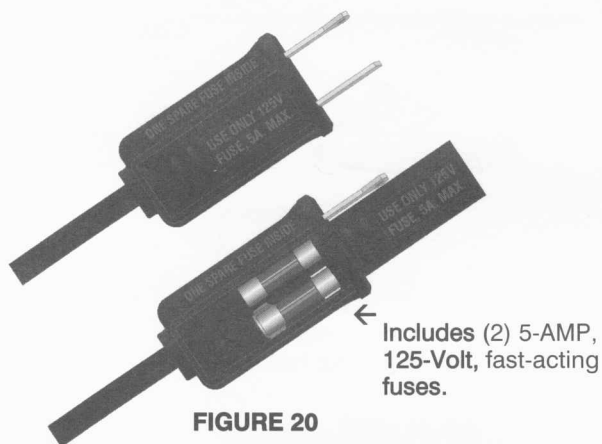

FIGURE 20

For several years we have included fused plugs on all Systems which protect pianos in the United Kingdom and “blown” plug fuses are a rare occurrence.

Warning: Add only the Damp-Chaser brand of humidifier treatment to the Humidifier water. Other brands of humidifier treatment may contain acids which may corrode strings and metal parts in the piano. The use of other humidifier treatment preparations will void the warranty of the Piano Life Saver System and may void the warranty of the piano manufacturer.

If tap water comes from a well or is “hard” water, meaning containing significant minerals, we recommend using distilled water. If distilled water is used, add Humidifier Treatment (according to the label instructions) to insure there are adequate electrolytes in the Humidifier to support operation of the yellow low water warning light. Without sufficient electrolytes, the light will blink continuously, even when the tank is full. **Do not put salt in the Humidifier, as it is corrosive.**

To fill the Humidifier tank, simply reach under the rim, pull the tubing out of the half clamps, connect the spout inside the tube, raise the watering can, and add water. After the Humidifier is filled, the watering can (which is still connected to the watering tube) should be lowered below the bottom rim so that any water remaining in the tube is drained into the watering can. Then, disconnect the watering can from the tube and push the tube back into the half clamps.

Humidifier Maintenance: To ensure a properly functioning Humidifier, the pads should be changed at least twice each year. This applies whether a Smart Bracket is used or not. Change them during the fall service of the piano and then again in the spring. Replacement pads can be obtained from any Damp-Chaser distributor. Clean the Humidifier once each year by removing and replacing the liner. Be sure the watering tube is inside the liner when it is replaced. The Tank must be lowered to do this. The holes in the new liner may be enlarged with a pair of scissors to make installations easier.

Smart Bracket Maintenance: If the System includes the optional Smart Bracket, the sensor wires can sense the pads are wicking water properly only if the wires are kept free from corrosion and minerals. During pad changing, remove the Bracket from the heater bar. Then, remove the mineral residue on the wires by scraping with the edge of a knife held perpendicular to the wires. Alternatively, it may be simpler to bring a new SB to replace the old one. Replacement SB's are available from your Damp-Chaser distributor.

DAMPP-CHASER'S TECHNICAL SERVICE DEPARTMENT IS AVAILABLE TO ANSWER ALL INSTALLATION QUESTIONS AT 800-438-1524.

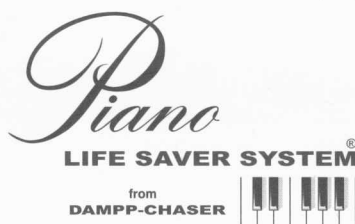

DAMPP-CHASER CORPORATION

Toll-free: 800-438-1524 • 828-692-8271 • Fax: 828-692-8272
 www.PianoLifeSaver.com • e-mail: piano@damp-chaser.com
 Post Office Box 1610 • Hendersonville, North Carolina 28793